

THE MAN TGE.

Technical Data.
Valid from 20th June 2022.



CONTENTS

The MAN TGE: a truck among vans.	2
The MAN TGE: now even more customizable to meet your needs.	3
MAN Service: safety first.	4
MAN TGE model overview.	5
Power train.	6
Dimensions.	7
Weights.	13
Tyre labels.	16
Noise emissions.	18
General information.	20

Find out more at www.van.man





THE MAN TGE: A TRUCK AMONG VANS.

The MAN TGE sets new standards for transporters in the 3.0–5.5 t class and impresses in everyday use with its high degree of efficiency, reliability and exemplary handling. Whether deployed on the building site, in forestry or municipal services, for courier or logistics services or for passenger transport – the MAN TGE will rise to the challenge. And when it comes to transporting goods in urban settings, with their zero emissions requirements, the fully electric MAN eTGE is available as a panel van, combi van, platform truck or tipper – and all for roughly the same low monthly cost as the diesel MAN TGE.

More options.

Thanks to its fully configurable body, it's easy to find a MAN TGE model that meets your needs:

- Panel vans available in three lengths and three heights
- Maximum load volume of up to 18.4 m³
- Chassis cab available in three lengths, or crew cab in two lengths
- A huge range of industry-specific configurations and extras as well as custom configurations ready ex works¹
- Every body type is available with front, rear or all-wheel drive.

More power.

Robust turbo diesel engines of 75 to 130 kW and up to 410 Nm torque guarantee a high level of driving comfort and cost-efficiency, and can be flexibly combined with innovative eight-gear automatic transmission. Meanwhile, the fully electric MAN eTGE offers a 100 kW electric engine² with a real range of 120–130 km³ for everyday use when fully charged.

More connectivity, comfort and safety.

With its open, spacious cockpit, the MAN TGE is great on the inside too, while its carefully considered storage system offers plenty of space for any tools and equipment you need. To help keep driver, vehicle and the environment well connected, there is the internet-enabled infotainment system and the MAN telematics box⁴, which, combined with the three-button module⁵, enables use of the MAN callout services (MAN info service, MAN breakdown service and emergency call). With a variety of innovative safety features, including emergency brake assist that comes as standard and many other optional driver assistance systems, you can drive with peace of mind now and in the future. Discover everything that is possible with the MAN Transporter TGE and electric MAN eTGE today.

¹ Some configurations and extras may incur an additional cost.

² Energy consumption according to WLTP: 29.1 kWh/100 km.

³ Range according to WLTP: 115 km (NEDC 173 km).

⁴ Not available with the eTGE or with vehicles without radio or with radio pre-installation.

⁵ Not available with the eTGE or with chassis cabs with custom configurations (e.g. cowl) or with vehicles without radio or with radio pre-installation.

THE MAN TGE: NOW EVEN MORE CUSTOMIZABLE TO MEET YOUR NEEDS¹

With its 2023 model, the MAN TGE is now one of the most versatile basic vehicles in the light commercial vehicle segment, 3.0–5.5 t class. Leveraging our extensive experience and special MAN design expertise, we can deliver tailored solutions that cover all your everyday requirements.

Everything at a glance

The ergonomic cockpit offers exceptional comfort, while the carefully considered storage system has space for everything. Meanwhile, the intuitive infotainment systems are easy to operate and available at three different function levels.



Innovation and safety

A number of driver assistance systems are available for your safety, including the standard emergency braking assist and active lane assist. And in emergency situations where you need help fast, you can get support in seconds with the digital callout services available via the three-button module 2.



E-mobility

Whether supplied ex works as a panel van, tipper, platform body or combi van, the MAN eTGE is a fully electric vehicle that can easily compete with the total cost of ownership of a MAN TGE diesel and is suitable for a wide range of uses.



Broad range of engines

The MAN TGE engine portfolio is characterized by high fuel efficiency without compromising on payload or performance. Available with front, rear or all-wheel drive, it's easy to find the right combination for every driving style.



MAN design expertise

With the MAN TGE, there are simply no limits to the number of body configurations available. From cranes to platforms and tow trucks: we have the right solution for every need.

¹ Features special equipment at extra cost. ² Not available with the eTGE, vehicles with custom configurations (e.g. cowl) or with vehicles without radio or with radio pre-installation.

MAN SERVICES: AN OVERVIEW.

MAN services

Once you choose MAN, you'll never look back. This goes not only for the MAN TGE; it applies to MAN repair and maintenance services as well. The tailored service agreements offer you complete peace of mind when it comes to planning and budgeting and relieves you of administrative work. From the entry-level contract ComfortOil to the all-round care-free package ComfortSuper, there is a suitable contract for every requirement. By combining it with an MAN warranty extension or the MAN mobility guarantee, our service can be extended to suit individual needs, guaranteeing maximum protection at minimum expense. You have access to durable, high-quality MAN original parts at any time, day or night. Alternatively you can choose professionally reconditioned MAN Genuine Parts ecoline in MAN quality which are more ecological and economical than new parts. Additionally, MAN original accessories offer a comprehensive range of products for comfort, transport and safety.

MAN DigitalServices

MAN DigitalServices provides a fast and straightforward introduction to digital fleet and vehicle management, so you can run your fleet more economically and efficiently over the long term. Test selected digital services free of charge for three months with the Free Trial option. You can find more information on this as well as on booking and the requirements for MAN DigitalServices in the Marketplace on the RIO platform at: <https://rio.cloud/de/marketplace/man-digital-services>

Digital services overview:

- Geo: Efficient route planning with an extensive range of maps and detailed driving history.
- MAN ServiceCare S (free): Proactive maintenance and repair management through MAN.
- MAN ServiceCare M: Personal maintenance and repair management.
- MAN Now: Over-the-air software upgrades.
- MAN Driver App (free): The perfect companion for drivers.

MAN Mobile24

Whether you are driving in the urban jungle or out in the woods: with MAN Mobile24, you will never be stranded – thanks to 24/7 protection, 365 days a year and approx. 2,000 MAN service centres and cooperation workshops all over Europe. If an incident occurs, call the Europe-wide phone number: 00800Mobile24 / 00800 66 24 53 24¹. You will be connected to one of our expert partners that can help you in 26 different languages. We offer you fast, reliable help in the event of a breakdown, support in booking appointments that can be planned for customers who are abroad and comprehensive tyre

service including tyre changes while on the road, as well as the best possible support through the connection to MAN ServiceCare. To view and track the current breakdown status, you can register for the MAN Mobile24 Tracking Link.

MAN financial services, MAN card and MAN rental

Individually designed financing products give you the flexibility you need to make buying your MAN TGE affordable. Meanwhile, leasing opportunities allow you to plan as effectively as possible – because you only pay for the time you are actually using the vehicle. Our insurance products provide comprehensive protection against damage caused by third-party or personal negligence. The MAN card (a LogPay product) simplifies international payments for fuel and services and your vehicle-related statements. And with our rental services, you can boost the capacity of your fleet for a predefined period at short notice. All of which means you can remain flexible and competitive. Contact us directly to arrange a personal consultation.

You can find more information and contact details at www.man.de/fs.

MAN ProfiDrive®







The MAN TGE is a true all-rounder, perfectly tailored to a driver's everyday tasks and challenges. Qualified MAN ProfiDrive® trainers can help you drive your MAN TGE more proactively, safely and efficiently, while reducing running costs at the same time. MAN ProfiDrive® also offers a variety of seminars specifically geared towards the transporter segment.





MAN TopUsed





A first-class offering for an outstanding transporter: MAN TopUsed is your partner for all things related to used vehicles purchased from official MAN used vehicle centres in more than 30 countries. You will receive comprehensive support in every decision, starting before you even purchase your vehicle.

¹ Free from landline numbers. Mobile charges may vary based on provider. If your provider does not support freecall numbers, please call +49 1805 3535 3333 (0.14 euros/min from German landlines. Mobile charges and costs from other countries depend on your plan).

MAN TGE MODEL OVERVIEW.

Panel van			
	Standard	Long	Extra long
	Length: 5,986 mm Wheelbase: 3,640 mm	Length: 6,836 mm Wheelbase: 4,490 mm	Length: 7,391 mm Wheelbase: 4,490 mm
Normal roof Height: 2,355 mm			
High roof Height: 2,590 mm			
Extra-high roof Height: 2,798 mm			

Cowl chassis			
	Standard	Long	Extra long
	Length: 5,968 ² mm Wheelbase: 3,640 mm	Length: 6,818 ² mm Wheelbase: 4,490 mm	Length: 7,211 ² mm Wheelbase: 4,490 mm
Cowl chassis Height: 2,305–2,327 ² mm			
Cowl chassis Flat frame Height: 2,305–2,312 mm			

Chassis cab			
	Standard	Long	Extra long
	Length: 5,968 ² mm Wheelbase: 3,640 mm	Length: 6,818 ² mm Wheelbase: 4,490 mm	Length: 7,211 ² mm Wheelbase: 4,490 mm
Chassis cab Height: 2,305–2,327 ² mm			
Crew cab Height: 2,321–2,352 ² mm			

Weights: 3.0 t, 3.5 t, 3.88 t, 4.0 t, 5.0 t, 5.5 t plus towing capacity of 2.0 to 3.5 t.

Engines: 2.0 L turbo diesel: 75 kW, 103 kW (light duty), 2.0 L twin-turbo diesel: 103 kW (heavy duty), 120 kW (heavy duty), 130 kW (light duty), electric: 100 kW.

Drives: front, rear or all-wheel drive.

Transmissions: six-gear manual transmission, eight-gear automatic transmission, one-gear electric.

¹ Also available as an electric transporter.

² Value applies to dual tyres.

POWER TRAIN.

Diesel engines	2.0 L 75 kW	2.0 L 103 kW	2.0 L 120 kW	2.0 L 130 kW	Electric motor	100 kW
Engine size [cm³]	1,968	1,968	1,968	1,968	Motor	Permanent magnet synchronous generator
Number of cylinders	4	4	4	4	Max. power [kW (HP)]	100 (136)
Max. power [kW (HP)]	75 (102)	103 (140)	120 (163)	130 (177)	at rpm [1/min]	3,300–11,700
at rpm [1/min]	3,000–3,500	3,500–3,600* / 3,600**	3,600	3,600	Max. torque [Nm]	290
Max. torque [Nm]	300	340* / 360**	410	410	at rpm [1/min]	0–3,300
at rpm [1/min]	1,400–2,250	1,600–2,250* / 1,500–2,500**	1,500–2,000	1,500–2,000	Nominal capacity [kWh]	35.8
Emissions	EU 6d ISC-FCM (AR)*	EU 6d ISC-FCM (AR)* / EuroVle**	EuroVle**	EU 6d ISC-FCM (AR)*	Fuel type	Electricity
Fuel type	Diesel, pursuant to DIN EN 590	Diesel, pursuant to DIN EN 590	Diesel, pursuant to DIN EN 590	Diesel, pursuant to DIN EN 590	Transmission	1-gear transmission
Transmission	6-gear manual transmission	6-gear manual transmission 8-gear automatic transmission ¹	6-gear manual transmission 8-gear automatic transmission	6-gear manual transmission 8-gear automatic transmission	Max. range [km]	WLTP 110/115 (173 NEDC)
Drive	Front-wheel drive	Front-wheel drive All-wheel drive Rear-wheel drive with super singles Rear-wheel drive with dual tyres	Rear-wheel drive with super singles Rear-wheel drive with dual tyres	Front-wheel drive All-wheel drive Rear-wheel drive with super singles Rear-wheel drive with dual tyres	Battery	Lithium-ion
					Charging	Alternating current (AC) ² Direct current (DC) ³

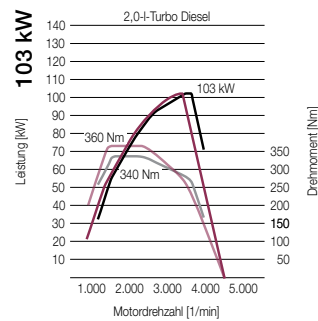
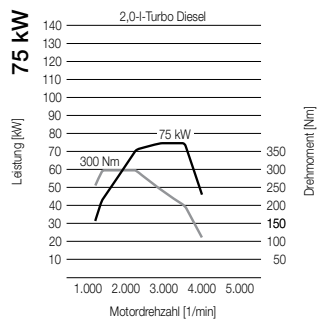

* for light duty ** for heavy duty

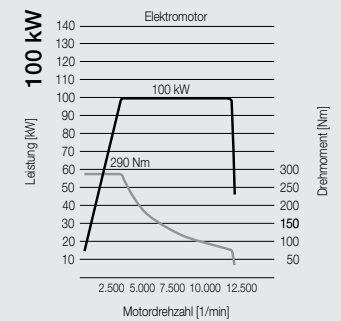
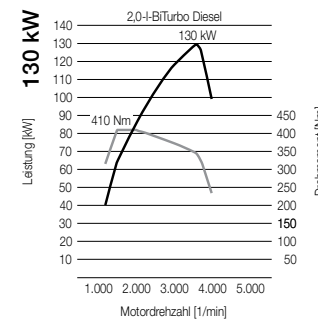
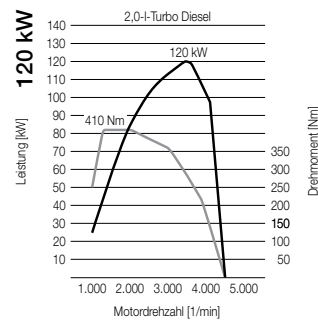

*Light duty homologation.
**Heavy duty homologation.
¹ Only with front-wheel drive.
² Up to 7.2 kW via Wallbox 5 hours 20 minutes.
³ Up to 40 kW via CCS 45 minutes for 80%.

DIMENSIONS.

MAN TGE panel van with normal roof

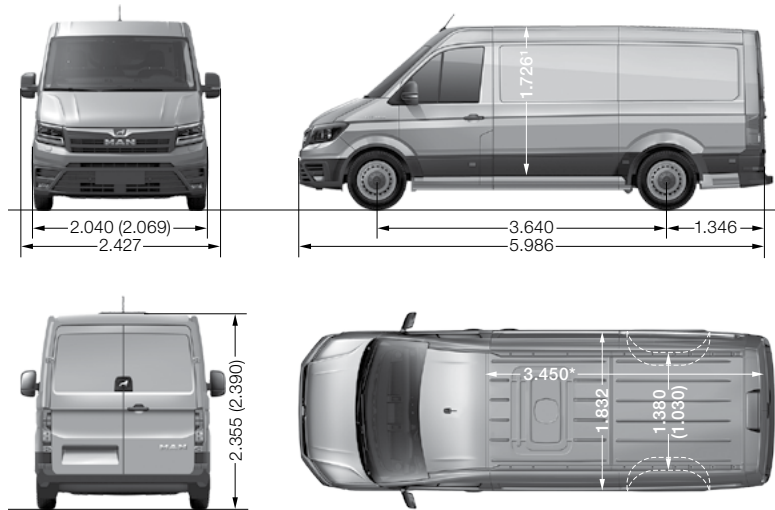

MAN TGE panel van with high roof

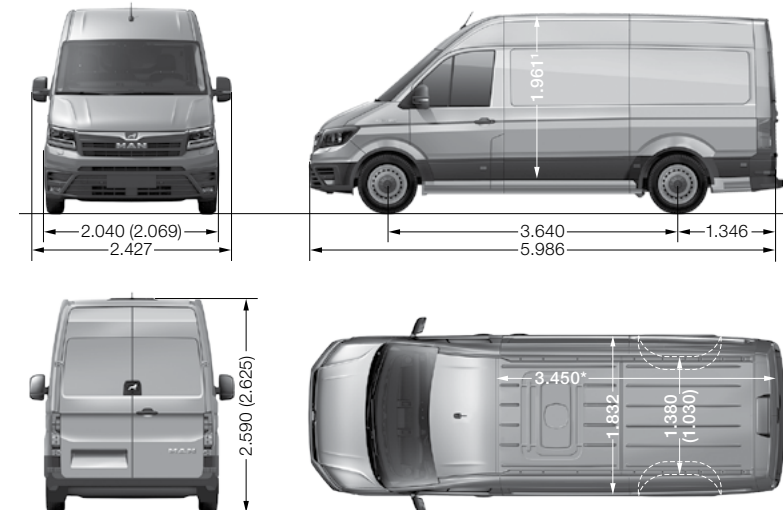

Cargo space, volume [m ³]	9.9 ²
Side sliding door, width x height [mm]	1,311 x 1,587 ³
Rear double doors, clear width x height [mm]	1,552 x 1,605 ⁴
Load sill height at rear [mm]	570 ⁵ (720)
Turning radius [m]	13.9–14.2

Cargo space, volume [m ³]	11.3 ²
Side sliding door, width x height [mm]	1,311 x 1,822 ³
Rear double doors, clear width x height [mm]	1,552 x 1,840 ⁴
Load sill height at rear [mm]	570 ⁵ (720)
Turning radius [m]	13.9–14.2

Values for 4x4 and rear-wheel drive with normal roof: 1,626¹/9.3²/1,487³/1,505⁴/670⁵.
 Values for 4x4, rear-wheel drive and electric drive with high roof: 1,861¹/10.7²/1,722³/1,740⁴/670⁵.
 Values in brackets apply to dual tyres.

All dimensions are based on standard vehicle configurations. Specified heights may vary by approximately ±40 mm depending on configuration. Vehicle illustrations are not to scale.
 *Long vehicle floors incl. subfloor storage compartment below divider wall. Length of loading compartment in upper section: 3,201 mm.

DIMENSIONS.

MAN TGE long panel van with high roof

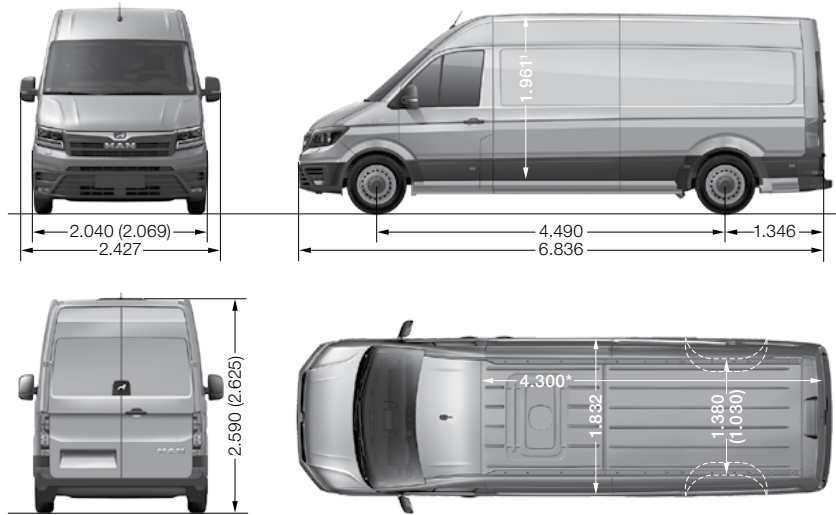

Cargo space, volume [m ³]	14.4 ²
Side sliding door, width x height [mm]	1,311 x 1,822 ³
Rear double doors, clear width x height [mm]	1,552 x 1,840 ⁴
Load sill height at rear [mm]	570 ⁵ (720)
Turning radius [m]	16.5–17.0

MAN TGE long panel van with extra-high roof

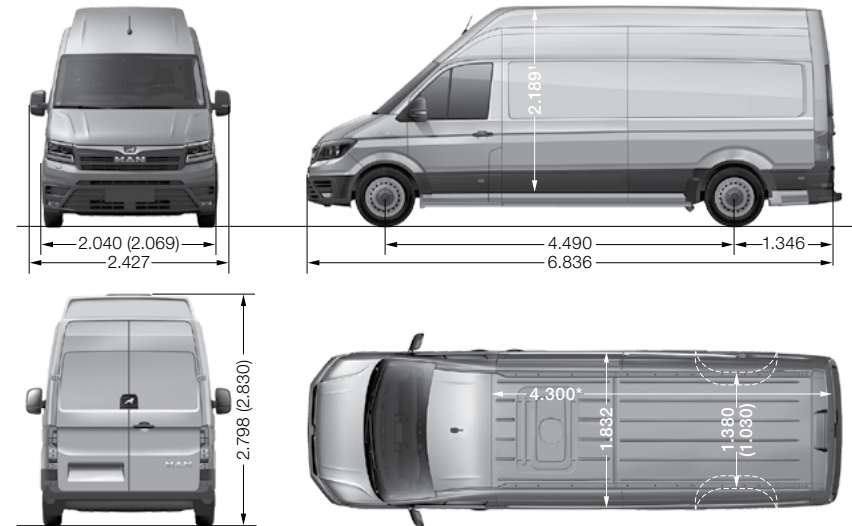

Cargo space, volume [m ³]	16.1 ²
Side sliding door, width x height [mm]	1,311 x 1,822 ³
Rear double doors, clear width x height [mm]	1,552 x 1,840 ⁴
Load sill height at rear [mm]	570 ⁵ (720)
Turning radius [m]	16.5–17.0

Values for 4x4 and rear-wheel drive with high roof: 1,861/13.6²/1,722³/1,740⁴/670⁵.
 Values for 4x4 and rear-wheel drive with extra-high roof: 2,089/15.3²/1,722³/1,740⁴/670⁵.
 Values in brackets apply to dual tyres.

All dimensions are based on standard vehicle configurations. Specified heights may vary by approximately ±40 mm depending on configuration. Vehicle illustrations are not to scale.
 *Long vehicle floors incl. subfloor storage compartment below divider wall. Length of loading compartment in upper section: 4,051 mm.

DIMENSIONS.

MAN TGE extra-long panel van with high roof

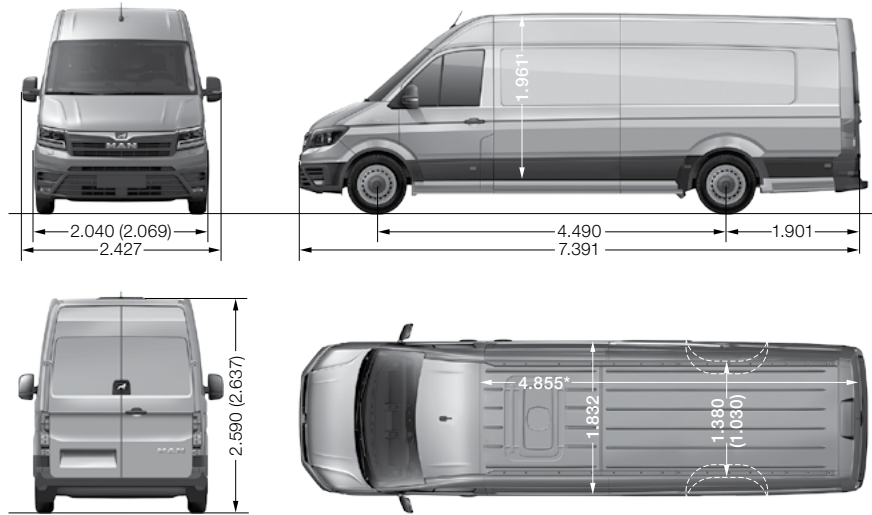

Cargo space, volume [m ³]	16.4 ²
Side sliding door, width x height [mm]	1,311 x 1,822 ³
Rear double doors, clear width x height [mm]	1,552 x 1,840 ⁴
Load sill height at rear [mm]	570 ⁵ (725)
Turning radius [m]	16.5–17.0

MAN TGE extra-long panel van with extra-high roof

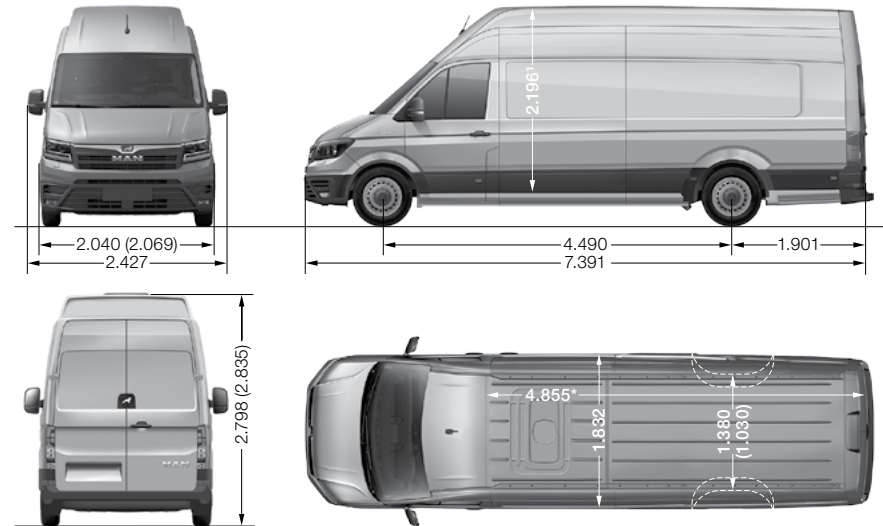

Cargo space, volume [m ³]	18.4 ²
Side sliding door, width x height [mm]	1,311 x 1,822 ³
Rear double doors, clear width x height [mm]	1,552 x 1,840 ⁴
Load sill height at rear [mm]	570 ⁵ (725)
Turning radius [m]	16.5–17.0

Values for 4x4 and rear-wheel drive with high roof: 1,861¹/15.5²/1,722³/1,740⁴/670⁵.
 Values for 4x4 and rear-wheel drive with extra-high roof: 2,096¹/17.5²/1,722³/1,740⁴/670⁵.
 Values in brackets apply to dual tyres.

All dimensions are based on standard vehicle configurations. Specified heights may vary by approximately ±40 mm depending on configuration. Vehicle illustrations are not to scale.
 *Long vehicle floors incl. subfloor storage compartment below divider wall. Length of loading compartment in upper section: 4,606 mm.

DIMENSIONS.

MAN TGE chassis cab/cowl chassis, single cab, standard

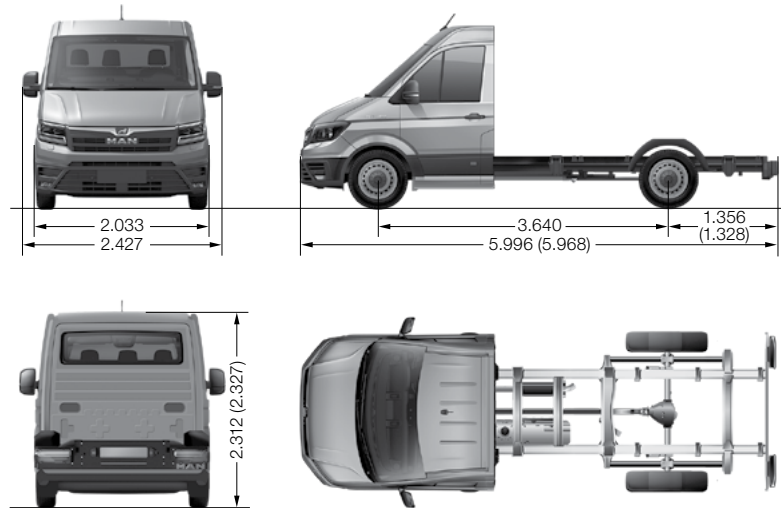

MAN TGE chassis cab/cowl chassis, single cab, long

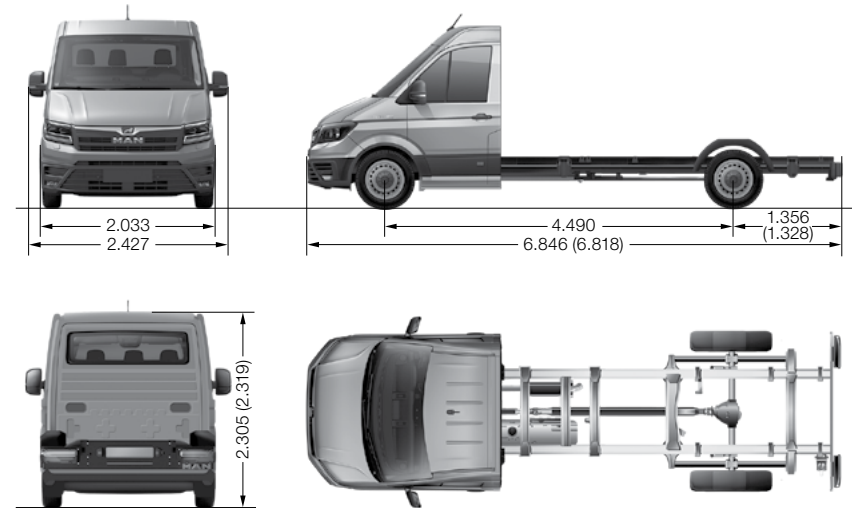

Frame, height [mm] Chassis cab at 3.5/5.0–5.5 kg total permissible weight	760/785
Frame, height [mm] Cowl chassis cab at 3.5/5.0–5.5 kg total permissible weight	760/785
Frame, height [mm] Cowl chassis with flat frame at 3.5 kg total permissible weight	570
Turning radius [m]	13.9–14.2
Flatbed length [mm]	3,500

Frame, height [mm] Chassis cab at 3.5/5.0–5.5 kg total permissible weight	760/785
Frame, height [mm] Cowl chassis cab at 3.5/5.0–5.5 kg total permissible weight	760/785
Frame, height [mm] Cowl chassis with flat frame at 3.5 kg total permissible weight	570
Turning radius [m]	16.5–17.0
Flatbed length [mm]	4,300

Values in brackets apply to dual tyres.

Flatbed length valid for ex works equipment.

All dimensions are based on standard vehicle configurations. Specified heights may vary by approximately ±40 mm depending on configuration. Vehicle illustrations are not to scale.

DIMENSIONS.

MAN TGE chassis cab/cowl chassis, single cab, extra long

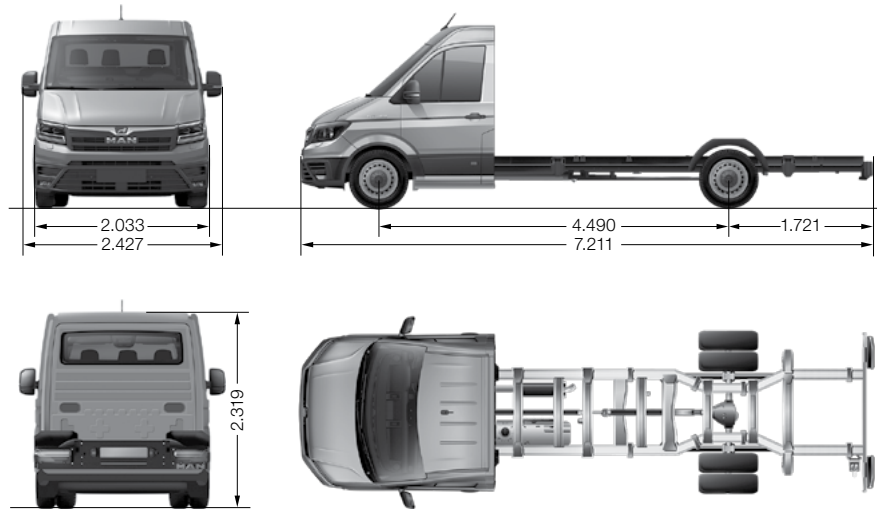

Frame, height [mm] Chassis cab at 3.5/5.0–5.5 kg total permissible weight	760/785
Frame, height [mm] Cowl chassis cab at 3.5/5.0–5.5 kg total permissible weight	760/785
Turning radius [m]	16.5–17.0
Flatbed length [mm]	4.700

Flatbed length valid for ex works equipment.
 All dimensions are based on standard vehicle configurations. Specified heights may vary by approximately ±40 mm depending on configuration. Vehicle illustrations are not to scale.

DIMENSIONS.

MAN TGE chassis cab, crew cab, standard

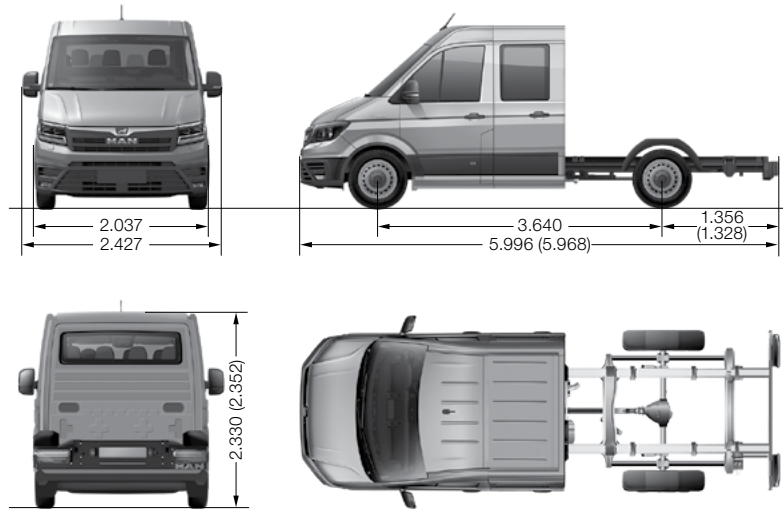

MAN TGE chassis cab, crew cab, long

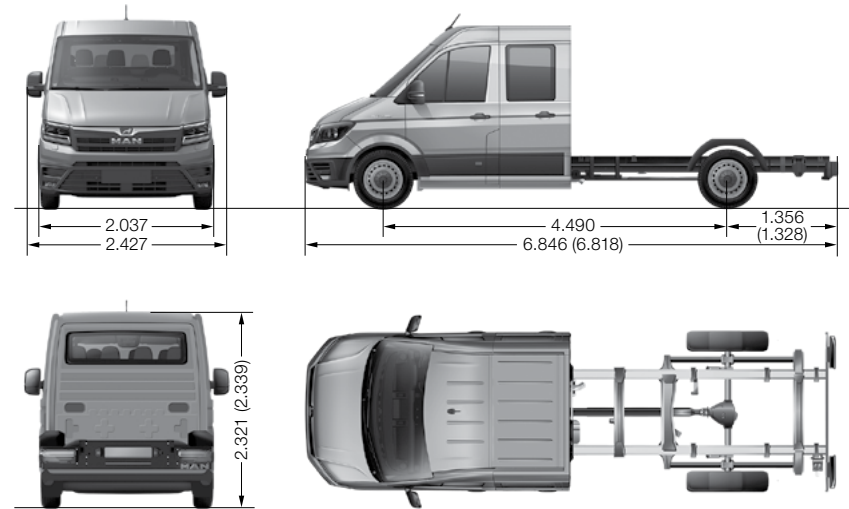

Frame, height [mm] Chassis cab at 3.5/5.0–5.5 kg total permissible weight	760/785
Turning radius [m]	13.9–14.2
Flatbed length [mm]	2,700

Frame, height [mm] Chassis cab at 3.5/5.0–5.5 kg total permissible weight	760/785
Turning radius [m]	16.5–17.0
Flatbed length [mm]	3,500

Values in brackets apply to dual tyres.
 Flatbed length valid for ex works equipment.
 All dimensions are based on standard vehicle configurations. Specified heights may vary by approximately ±40 mm depending on configuration. Vehicle illustrations are not to scale.

WEIGHTS.

MAN TGE panel van

Drive	Total permissible weight [kg]	Engine power [kW (HP)]	Maximum towing capacity (braked), at 12% gradient/unbraked [kg]**	Total permissible weight [kg]	Total permissible axle load front/rear [kg]	Standard		Long		Extra long	
						Min. unladen weight [kg]*****	Max. laden weight [kg]*****	Min. unladen weight [kg]*****	Max. laden weight [kg]*****	Min. unladen weight [kg]*****	Max. laden weight [kg]*****
Front wheel drive	3.000*	75 (102) LD	2.500/750	5.500	1.800/2.100	2.112	888	-	-	-	-
		103 (140) LD/HD	3.000/750	6.000	1.800/2.100	2.121	879	-	-	-	-
		120 (163) HD	3.000/750	6.000	1.800/2.100	2.130	870	-	-	-	-
		130 (177) LD	3.000/750	6.000	1.800/2.100	2.130	870	-	-	-	-
Front wheel drive	3.500	75 (102) LD	2.500/750	5.500	1.800***/2.100	2.112	1.388	2.248	1.252	2.319	1.181
		103 (140) LD/HD	3.000/750	6.000	1.800***/2.100	2.121	1.379	2.257	1.243	2.328	1.172
		120 (163) HD	3.000/750	6.000	1.800***/2.100	2.130	1.370	2.266	1.234	2.337	1.163
		130 (177) LD	3.000/750	6.000	1.800***/2.100	2.130	1.370	2.266	1.234	2.337	1.163
All-wheel drive	3.500	103 (140) LD/HD	3.000/750	6.000	1.800***/2.100	2.248	1.252	2.384	1.116	2.455	1.045
		120 (163) HD	3.000/750	6.000	1.800***/2.100	2.257	1.243	2.393	1.107	2.464	1.036
		130 (177) LD	3.000/750	6.000	1.800***/2.100	2.257	1.243	2.393	1.107	2.464	1.036
Rear-wheel drive	3.500	103 (140) HD	3.000/750	6.500	1.800***/2.250	2.240	1.260	2.385	1.115	-	-
		120 (163) HD	3.500/750	7.000	1.800***/2.100	2.240	1.260	2.385	1.115	-	-
Rear-wheel drive	5.000	103 (140) HD	3.500/750	7.500	2.200/3.500	2.462	2.538	2.612	2.388	2.682	2.318
		120 (163) HD	3.500/750	8.000	2.200/3.500	2.457	2.543	2.597	2.403	2.683	2.317
Rear-wheel drive	5.500	103 (140) HD	3.500/750	7.500	2.200/4.000	2.484	3.016	2.633	2.867	2.704	2.796
		120 (163) HD	3.500/750	8.000	2.200/4.000	2.479	3.021	2.619	2.881	2.704	2.796
Electric drive	3.500	100 (136)	-	-	2.100/2.100	2.518	982	-	-	-	-

Roof loads

Model	Roof load [kg]
Normal roof	300
High roof	150
Extra-high roof****	-

Vertical loads

With tow weight [kg]	Vertical load [kg]	
	Front-wheel/all-wheel drive	Rear-wheel drive
2,500	100	-
3,000	120	140
3,500	-	140

* Available on request.

** The specified values are the maximum permissible tow weights for the relevant engine/transmission. Depending on vehicle configuration, these values may be lower.

*** Depending on vehicle configuration, the permissible axle load may rise to 2,100 kg. This may affect the minimum payload/maximum cargo load.

**** For vehicles with extra-high roofs, no specific roof load is defined ex works.

***** The specified values apply to vehicles with six-gear manual transmissions. Unladen weight and cargo load for eight-gear automatic transmissions may differ.

WEIGHTS.

MAN TGE chassis cab, single cab

Drive	Total permissible weight [kg]	Engine power [kW (HP)]	Maximum tow weight (braked), at 12% gradient/unbraked [kg]*	Total permissible weight [kg]	Total permissible axle load front/rear [kg]	Standard		Long		Extra long	
						Min. unladen weight [kg]***	Max. cargo load [kg]***	Min. unladen weight [kg]***	Max. cargo load [kg]***	Min. unladen weight [kg]***	Max. cargo load [kg]***
Front wheel drive	3.500	75 (102) LD	2.500/750	5.500	1.800**/2.100	1.852	1.648	1.882	1.618	-	-
		103 (140) LD/HD	3.000/750	6.000	1.800**/2.100	1.857	1.643	1.887	1.613	-	-
		120 (163) HD	3.000/750	6.000	1.800**/2.100	1.866	1.634	1.897	1.603	-	-
		130 (177) LD	3.000/750	6.000	1.800**/2.100	1.866	1.634	1.897	1.603	-	-
All-wheel drive	3.500	103 (140) LD/HD	3.000/750	6.000	1.800**/2.100	1.984	1.516	2.014	1.486	-	-
		120 (163) HD	3.000/750	6.000	1.800**/2.100	1.993	1.507	2.023	1.477	-	-
		130 (177) LD	3.000/750	6.000	1.800**/2.100	1.993	1.507	2.023	1.477	-	-
Rear-wheel drive	3.500	103 (140) HD	3.000/750	6.500	1.800**/2.250	1.962	1.538	2.002	1.498	-	-
		120 (163) HD	3.500/750	7.000	1.800**/2.250	1.967	1.533	2.007	1.493	-	-
Rear-wheel drive	5.000	103 (140) HD	3.500/750	7.500	2.200/3.500	2.132	2.868	2.175	2.825	2.190	2.810
		120 (163) HD	3.500/750	8.000	2.200/3.500	2.135	2.865	2.178	2.822	2.193	2.807
Rear-wheel drive	5.500	103 (140) HD	3.000/750	7.500	2.200/4.000	2.153	3.347	2.196	3.304	2.211	3.389
		120 (163) HD	3.500/750	8.000	2.200/4.000	2.157	3.343	2.200	3.300	2.215	3.285

Roof loads

Model	Roof load [kg]
Spoiler	50
Roof sleeper	100

Vertical loads

With tow weight [kg]	Vertical load [kg]	
	Front-wheel/all-wheel drive	Rear-wheel drive
2,500	100	-
3,000	120	140
3,500	-	140

* The specified values are the maximum permissible tow weights for the relevant engine/transmission. Depending on vehicle configuration, these values may be lower.

** Depending on vehicle configuration, the permissible axle load may rise to 2,100 kg. This may affect the minimum payload/maximum cargo load.

*** The specified values apply to vehicles with six-gear manual transmissions. Unladen weight and cargo load for eight-gear automatic transmissions may differ.

WEIGHTS.

MAN TGE chassis cab, crew cab

Drive	Total permissible weight [kg]	Engine power [kW (HP)]	Maximum tow weight (braked), at 12% gradient/unbraked [kg]*	Total permissible weight [kg]	Total permissible axle load front/rear [kg]	Standard		Long	
						Min. unladen weight [kg]***	Max. cargo load [kg]***	Min. unladen weight [kg]***	Max. cargo load [kg]***
Front wheel drive	3.500	75 (102) LD	2.000/750	5.500	1.800**/2.100	2.026	1.474	2.067	1.433
		103 (140) LD/HD	2.800/750	6.000	1.800**/2.100	2.032	1.468	2.072	1.428
		120 (163) HD	2.800/750	6.000	1.800**/2.100	2.041	1.459	2.082	1.418
		130 (177) LD	3.000/750	6.000	1.800**/2.100	2.041	1.459	2.082	1.418
All-wheel drive	3.500	103 (140) LD/HD	2.800/750	6.000	1.800**/2.100	2.159	1.341	2.199	1.301
		120 (163) HD	2.800/750	6.000	1.800**/2.100	2.168	1.332	2.208	1.292
		130 (177) LD	2.800/750	6.000	1.800**/2.100	2.168	1.332	2.208	1.292
Rear-wheel drive	3.500	103 (140) HD	3.000/750	6.500	1.800**/2.250	2.137	1.363	2.187	1.313
		120 (163) HD	3.500/750	7.000	1.800**/2.250	2.141	1.359	2.192	1.308
Rear-wheel drive	5.000	103 (140) HD	3.500/750	7.500	2.200/3.500	2.281	2.719	2.392	2.671
		120 (163) HD	3.500/750	8.000	2.200/3.500	2.284	2.716	2.333	2.667
Rear-wheel drive	5.500	103 (140) HD	3.000/750	7.500	2.200/4.000	–	–	2.351	3.149
		120 (163) HD	3.500/750	8.000	2.200/4.000	–	–	2.354	3.146

Vertical loads

With tow weight [kg]	Vertical load [kg]	
	Front-wheel/all-wheel drive	Rear-wheel drive
2,500	100	–
3,000	120	140
3,500	–	140











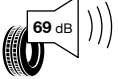

*The specified values are the maximum permissible tow weights for the relevant engine/transmission. Depending on vehicle configuration, these values may be lower.

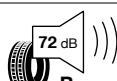
**Depending on vehicle configuration, the permissible axle load may rise to 2,100 kg. This may affect the minimum payload/maximum cargo load.

*** The specified values apply to vehicles with six-gear manual transmissions. Unladen weight and cargo load for eight-gear automatic transmissions may differ.

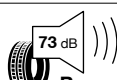

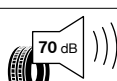





TYRE LABELLING.

MAN TGE

Summer tyres	Size	Tyre class	Fuel efficiency	Wet grip	Exterior noise level	Snow grip	Ice grip
	205/75 R 16 C 113/111	C2	B	A	 	-	-
	235/65 R 16 C 115/113	C2	B	A-B	 	-	-
	235/65 R 16 C 121/119	C2	B	A		-	-
	235/60 R 17 C 117/115	C2	B	A		-	-
All-season tyres	Size	Tyre class	Fuel efficiency	Wet grip	Exterior noise level	Snow grip	Ice grip
	205/75 R 16 C 113/111	C2	B-C	A-B			-
	235/65 R 16 C 115/113	C2	B	A			-
	235/65 R 16 C 121/119	C2	B	A			-
	285/55 R16 C 126/124	C3	D	A			-

TYRE LABELLING.

MAN TGE

Winter tyres	Size	Tyre class	Fuel efficiency	Wet grip	Exterior noise level	Snow grip	Ice grip
	205/75 R 16 C 113/111	C2	E	B			-
	235/65 R 16 C 115/113	C2	C-E	B	 - 		-
	235/65 R 16 C 121/119	C2	C	B			-
	205/70 R 17 C 115/113	C2	C	B			-



Rolling resistance/fuel efficiency – The fuel efficiency class of tyres varies depending on the rolling resistance, ranging from
 – A tyres are the most efficient and save fuel
 – E tyres are the least efficient and use the most fuel.



Wet grip – The wet grip rating provides information on the braking properties of a tyre in wet conditions and ranges from A (highest safety level) to E (lowest safety level).



Exterior noise level – A quieter tyre makes for a more comfortable drive and is better for the environment by emitting less noise. The noise level is measured in decibels (dB) and categorized by three levels.



Snow grip – Tyres carrying this label are suitable for use in cases of heavy snow. Only tyres with this marking on the tyre label or flank are acceptable winter tyres.



Ice grip – This label identifies tyres that are designed for roads covered in ice or packed snow. This label will only be visible if the tyres are suitable for use in conditions like this.

You will receive detailed information on tyre labelling when configuring your vehicle and in your quote. If you have any questions, your MAN Service Partner can also provide you with comprehensive information.

You can learn more about tyre labelling in general on the website of the European Commission: [Tyres | European Commission \(europa.eu\)](https://www.europa.eu/tyres)

To a large extent, the actual fuel savings and traffic safety depend on the driver and style of driving: – Fuel consumption can be significantly reduced through environmentally conscious driving. – To improve fuel efficiency and wet grip, tyre pressures should be checked regularly. – Always bear stopping distances in mind. – Ice tyres are designed for roads covered in ice or packed snow and should only be used in extremely difficult weather conditions (e.g. very low temperatures). The use of ice tyres in less difficult conditions (e.g. in wet weather or warmer temperatures) may lead to suboptimal performance, particularly in terms of wet grip, handling and wear and tear.

For reasons relating to logistics and production, it is not possible to order a specific tyre brand.

NOISE EMISSIONS.

MAN TGE panel van

Type	Category	Engine power [kW]	Drive	Transmission	Emissions	Driving noise [dB(A)]	Stationary noise [dB(A)]
Panel van	N1	75	Front	Manual	Light Duty	70,00	75,00
Panel van	N1	103	Front	Manual	Light Duty	71,00	74,00
Panel van	N1	103	Front	Manual	Heavy Duty	72,00	76,00
Panel van	N2	103	Front	Manual	Heavy Duty	67,00	76,00
Panel van	N1	130	Front	Manual	Light Duty	71,00	78,00
Panel van	N2	130	Front	Manual	Light Duty	68,00	78,00
Panel van	N1	103	Front	Automatic	Heavy Duty	71,00	77,00
Panel van	N2	103	Front	Automatic	Heavy Duty	71,00	77,00
Panel van	N1	130	Front	Automatic	Light Duty	73,00	78,00
Panel van	N2	130	Front	Automatic	Light Duty	72,00	78,00
Panel van	N1	103	All-wheel	Manual	Light Duty	72,00	75,00
Panel van	N1	103	All-wheel	Manual	Heavy Duty	72,00	77,00
Panel van	N2	103	All-wheel	Manual	Heavy Duty	70,00	77,00
Panel van	N1	130	All-wheel	Manual	Light Duty	71,00	79,00
Panel van	N1	130	All-wheel	Automatic	Light Duty	73,00	77,00
Panel van	N2	130	All-wheel	Automatic	Light Duty	73,00	77,00
Panel van	N1	103	Rear (single)	Manual	Heavy Duty	72,00	78,00
Panel van	N2	103	Rear (single)	Manual	Heavy-Duty	67,00	78,00
Panel van	N1	120	Rear (single)	Manual	Heavy Duty	72,00	76,00
Panel van	N2	120	Rear (single)	Manual	Heavy Duty	66,00	76,00
Panel van	N1	103	Rear (dual)	Manual	Heavy Duty	71,00	78,00
Panel van	N2	103	Rear (dual)	Manual	Heavy Duty	69,00	78,00
Panel van	N1	120	Rear (dual)	Manual	Heavy Duty	72,00	77,00
Panel van	N2	120	Rear (dual)	Manual	Heavy Duty	69,00	77,00
Panel van	N1	120	Rear (dual)	Automatic	Heavy Duty	72,00	76,00
Panel van	N2	120	Rear (dual)	Automatic	Heavy Duty	72,00	76,00
Panel van	N1	100	Front	1-gear transmission	Elektro	71,00	-

N1: Vehicles for transporting goods with a permissible total weight of up to 3.5 t
N2: Vehicles for transporting goods with a permissible total weight of more than 3.5 t

NOISE EMISSIONS.

MAN TGE chassis cab

Type	Category	Engine power [kW]	Drive	Transmission	Emissions	Driving noise [dB(A)]	Stationary noise [dB(A)]
Chassis cab	N1	75	Front	Manual	Light Duty	70,00	75,00
Chassis cab	N1	103	Front	Manual	Light Duty	71,00	74,00
Chassis cab	N1	103	Front	Manual	Heavy Duty	72,00	76,00
Chassis cab	N2	103	Front	Manual	Heavy Duty	67,00	76,00
Chassis cab	N1	130	Front	Manual	Light Duty	71,00	78,00
Chassis cab	N1	103	Front	Automatic	Light Duty	73,00	78,00
Chassis cab	N1	103	Front	Automatic	Heavy Duty	71,00	77,00
Chassis cab	N2	103	Front	Automatic	Heavy Duty	71,00	77,00
Chassis cab	N1	130	Front	Automatic	Light Duty	73,00	78,00
Chassis cab	N1	103	All-wheel	Manual	Light Duty	72,00	75,00
Chassis cab	N1	103	All-wheel	Manual	Heavy Duty	72,00	77,00
Chassis cab	N2	103	All-wheel	Manual	Heavy Duty	70,00	77,00
Chassis cab	N1	130	All-wheel	Manual	Light Duty	71,00	79,00
Chassis cab	N1	130	All-wheel	Automatic	Light Duty	73,00	77,00
Chassis cab	N1	103	Rear (single)	Manual	Heavy Duty	72,00	78,00
Chassis cab	N2	103	Rear (single)	Manual	Heavy Duty	67,00	78,00
Chassis cab	N1	120	Rear (single)	Manual	Heavy Duty	72,00	76,00
Chassis cab	N2	120	Rear (single)	Manual	Heavy Duty	66,00	76,00
Chassis cab	N2	103	Rear (dual)	Manual	Heavy Duty	69,00	78,00
Chassis cab	N1	103	Rear (dual)	Manual	Heavy Duty	71,00	78,00
Chassis cab	N2	120	Rear (dual)	Manual	Heavy Duty	69,00	77,00
Chassis cab	N1	120	Rear (dual)	Manual	Heavy Duty	72,00	77,00
Chassis cab	N2	120	Rear (dual)	Automatic	Heavy Duty	72,00	76,00
Chassis cab	N1	120	Rear (dual)	Automatic	Heavy Duty	72,00	76,00

N1: Vehicles for transporting goods with a permissible total weight of up to 3.5 t

N2: Vehicles for transporting goods with a permissible total weight of more than 3.5 t

GENERAL INFORMATION.

The prices specified are the non-binding recommendations of MAN Truck & Bus SE ex works, not including transportation costs.

Vehicle illustrations in this publication may feature custom configurations and equipment that are subject to additional costs. Please note that some equipment may be subject to certain restrictions in how it can be combined, or may not be combined at all, and may be subject to legal regulations. MAN shall not accept any liability for the inappropriate use of this equipment.

Some custom configurations and equipment may lead to longer delivery times for vehicles. Please discuss any specific requests with a MAN partner. Only your MAN partner can check the requested equipment/combinations and the accuracy and completeness of the information in the order system they have access to.

Where a trademark in this document is not marked with a ® symbol, this does not imply that the trademark is not registered and/or that it may be used without prior written permission of the MAN Group. The product name AdBlue® is a registered trademark of the German Association of the Automotive Industry (VDA). iPod/iPad/iPhone are trademarks of Apple Inc.

Our vehicles come with summer tyres fitted as standard. Effective 4 December 2010, if you are an individual or business domiciled in Germany, you are legally required to fit your vehicle with M+S or all-season tyres in the event of black ice, packed snow, mud/slush or frost. Your MAN partner will be happy to advise you.

All information in this publication is based on the German market and is correct to the best of our knowledge at the time of going to print.

The engines are equipped with a multi-stage exhaust treatment system (diesel particulate filter and selective catalytic reduction [SCR] catalytic converter). The SCR catalytic converter converts the exhaust gas component nitrogen oxide (NO_x) into nitrogen (N_2) and water (H_2O), without forming unwanted by-products. The conversion involves the use of a synthetically made aqueous urea solution, for example, AdBlue® (ISO 22241-1/AUS 32), which is fed into an auxiliary tank. Depending on the vehicle, a customer may need to top up AdBlue® themselves between service appointments, or have it topped up by their MAN partner.

Vehicle unladen weights include 68 kg for the driver, 7 kg for luggage, all consumables and a fuel level of 90%, in accordance with Regulation (EU) No. 1230/2012 in its most recent version. Special equipment or equipment lines may affect the unladen weight. The actual payload of a vehicle, which is the difference between the unladen weight and the total permissible weight, can therefore only be calculated by weighing the vehicle in question.

As elevation increases, the engine power decreases. With each additional 1,000 m starting at 1,000 m above sea level, the total weight (permissible tow weight + permissible total weight of the towing vehicle) should be reduced by 10%.

Actual colours may vary from those shown in illustrations due to the printing process.

In the vehicle categories N1, N2, the refrigerant R1234yf is used for all diesel engines. The Global Warming Potential (GWP) value of the refrigerant is 4 (refrigerant R1234yf). Fill levels depend on the air conditioning (AC) compressor and range from 540 to 570 g for one AC compressor and from 785 to 815 g for two. For the eTGE, the refrigerant R134a is used. The GWP value of

GENERAL INFORMATION.

the used refrigerant is 1,430 (refrigerant R134a). The fill levels depend on the AC compressor and range from 560 to 590 g.

The fuel consumption and emissions values specified were calculated in accordance with legally defined processes. Since 1 September 2017, new vehicles are type approved according to the Worldwide Harmonized Light Vehicles Test Procedure (WLTP), a realistic testing method for determining a vehicle's fuel consumption and CO₂ emissions. Since 1 September 2018, WLTP also replaces the New European Driving Cycle (NEDC) for light-duty vehicles.

Where fuel consumption and emissions values are given as ranges, they do not relate to a specific vehicle and are not an element of the quote. Their sole purpose is to allow a comparison between different vehicle types.

Additional equipment and accessories (attachments, tyre formats, etc.) may change relevant vehicle parameters such as weight, rolling resistance and aerodynamics and, in addition to weather/traffic conditions and driving style, may affect the fuel consumption, electricity consumption, CO₂ emissions and the performance values of a vehicle.

Further information:

This price list is effective from 20 June 2022 for the MAN TGE, model year 2023. Subject to changes and errors.

Service appointments at MAN fall under "Oil change service" or "Inspection". The service interval feature on the console display provides a reminder of when the next service is due.

Return and recycling of scrap vehicles:

MAN is tackling the biggest challenges of our times head on and considering them in all new products bearing the MAN brand. This includes protecting the environment and conserving resources. All MAN TGEs can be recycled in an environmentally friendly way and can generally be returned free of charge, subject to national laws and regulations. You can find more information on the return and recycling of scrap vehicles at <https://www.man.eu/scrapvehiclerecycling> or from your local MAN sales office/service centre.

This document is an appendix to MAN TGE sales literature.

The price list contains legal data from REGULATION (EU) No. 540/2014 OF THE EUROPEAN PARLIAMENT AND OF THE COUNCIL of 16 April 2014 and pertaining to EU regulation 2020/740, which covers the labelling of tyres in relation to fuel efficiency, wet grip and noise emissions.

MAN Truck & Bus SE

Dachauer Straße 667

80976 Munich

Germany

www.van.man

02/2023

Text and images non-binding. Subject to changes due to technical advancements. All data in this publication is correct at the time of going to print.

MAN Truck & Bus – a member of the TRATON GROUP